

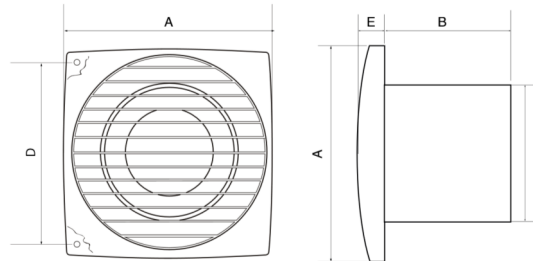

- Aria 100B - 90000687
- Aria 100PC - 90001400
- Aria 100T - 90000688
- Aria 100HT - 90000689
- Aria 100MST - 90000690



Fan Dimensions



Model	A	B	C	D	E
Aria 100	150	102	100	122	17

Fan Overview

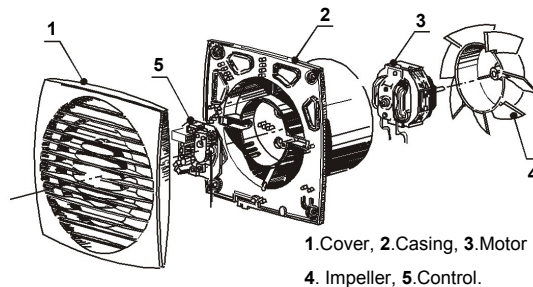

Page 2 of 16

Range Overview

Aria fans are designed for ventilation of domestic premises i.e. bathrooms, toilets and shower rooms. They are recommended for 'through the wall' installation.

The Aria 100B model may be used as a simple extract fan operated by a remote switch.

The Aria 100PC model may be used as a simple extract fan operated by a remote switch and a pull cord.

The Aria 100T model includes an adjustable timer function 2 to 30 minutes.

The Aria 100HT model includes an adjustable timer function 2 to 30 minutes and an adjustable humidity function 60 to 90% RH.

The Aria 100MST models includes adjustable timer function 2 to 30 minutes and motion sensing.

Fan Size	Max flow, m ³ /h	Max Pressure Pa	Nominal power, W	Noise level dB(A)
100mm	66.5	31.8	6	26

Page 3 of 16

Electrical Installation

The Aria fan range is IPX4 rated and is suitable for mounting in Zone 2 in bathrooms, toilets, kitchens, utility rooms and inside shower cubicles when installed with a 30mA RCD. In addition AFDD protection is also required.

The fan requires a 220 - 240V 50Hz single phase supply. Class II equipment. BS EN 60417. An external 3A fuse is required for each fan unit. Cable sizes (max): Fixed flat wiring 2 core 1mm², 3 core 1/1.5mm²

All electrical installation work to be carried out by a competent person in compliance with the relevant Building Regulations/Standards as well as the current edition of BS7671 (IET Wiring Regulations).

Important Notes

The Aria range also complies with the requirements of the EU norms and directives. Do not place the ventilator near direct heat sources, e.g. radiant heaters, or where temperatures can exceed 40°C (104°F). Precautions must be taken to avoid back flow of gases in rooms with open flue fuel burning appliances.

Page 4 of 16

Electrical Installation

Aria 100B, Aria 100PC, Aria 100MST
Wiring for fans with no external switching

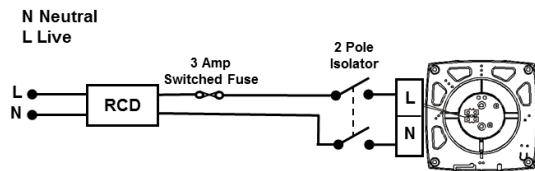

Aria 100T, Aria 100HT
Wiring for fans with external switching

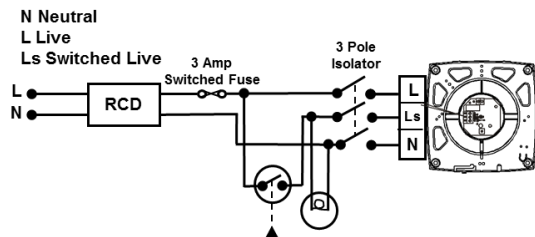

Note: An external switch can be connected to the Live for Aria 100B and Aria 100PC fans.

Page 5 of 16

Mechanical Installation

Aria fans can be wall mounted.

For mounting the fan, a ø100mm hole is required for the spigot, as well as at least two holes for the mounting screws. When mounting the fan, remove the front cover and place the fan into the pre drilled hole. Make sure that the spigot fits into any pre-installed ducting. Wire the fan appropriately according to page 5, ensuring that the cables from the fan are routed through the provided cable hole.

Use at least two mounting screws to secure the fan to the ceiling or wall ensuring not to over tighten and replace the front cover with the retention screw. Ensure free running of the fan impeller and that flexible duct connections are not over tightened to the fan outlet spigot.

Airflow recommends that rigid ducting is used instead of flexible ducting, this will ensure maximum performance.

Page 6 of 16

Fan Adjustment - Timer

The fan with timer function switches on when the voltage is supplied to the Ls terminal via an external switch.

After the voltage to the Ls terminal is disconnected the fan continues to run for the set run on timer period between 2 and 30 minutes. The run on timer period is adjusted by turning the potentiometer (T) clockwise to increase and anti-clockwise to decrease.

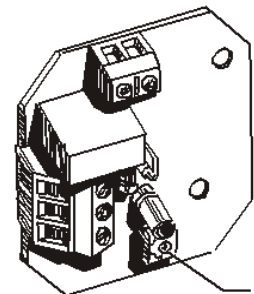

Page 7 of 16

Fan Adjustment - Humidity & Timer

Humidity and timer functions are activated when the voltage is supplied to the Ls terminal via an external switch or when the humidity level rises above the set % RH level (adjustable between 60 and 90% RH). After the voltage to the Ls terminal is disconnected or the humidity level falls below the set %RH level, the fan continues to run for the set overrun period between 2 and 30 minutes.

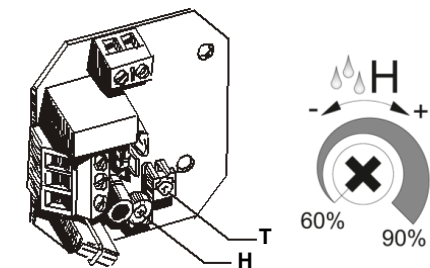

The humidity level is adjusted by turning the potentiometer (H) clockwise to increase and anti-clockwise to decrease. To set the maximum humidity level the potentiometer (H) has to set at the max position (90%).

See page 7 "Fan adjustment -Timer" for timer adjustment instructions.

Page 8 of 16

Fan Adjustment - Motion Sensor & Timer

The fan with motion sensor and timer function switches on when movement is detected between a distance of 1 and 4 meters from the fan. The sensor has a detection angle of 100° horizontally.

Once movement ceases, the fan continues to run for the set overrun period which is adjustable between 2 and 30 minute.

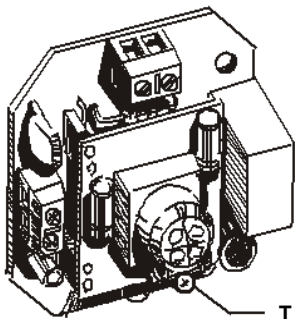

Page 9 of 16

Best Practice Recommendations

The Building Regulations 2010, Statutory Instrument Part 9, paragraph 42, imposes a requirement that testing and reporting of mechanical ventilation performance is conducted in accordance with an approved procedure.

Compliance with this requirement by an assessed and registered 'Competent Person' should follow a 'Best Practice' process and adopt air flow measurement, Method A – The Unconditional Method – using a suitable UKAS certified measuring instrument. Generically referred to as a 'Zero Pressure Air Flow Meter' or 'Powered Flow Meter'.

Further information on this method is detailed in NHBC Building Regulations Guidance Note G272a 10/13 and BSRIA 'A Guide to Measuring air flow rates document BG46/2015.

Page 14 of 16

Fan Assembly - Timer / Humidity & Timer

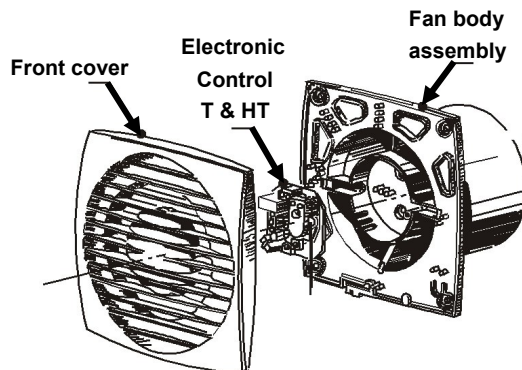

Page 10 of 16

Maintenance

SAFETY FIRST: ALWAYS ISOLATE THE FAN UNIT FROM THE POWER SUPPLY BEFORE REMOVING THE COVER.

When installed according to these instructions the Aria range is completely safe. The materials used do not constitute a hazard.

Cleaning

The external housing of the fan can be wiped with a damp cloth. Do not use household cleaners containing abrasives.

Note: Always isolate the fan when cleaning. Never clean any parts of the fan assembly by immersing in water or using a dishwasher.

Warning

This appliance can be used by children aged from 8 years and above and persons with reduced physical, sensory or mental capabilities or lack of experience and knowledge if they have been given supervision or instruction concerning use of the appliance in a safe way and understand the hazards involved. Children shall not play with the appliance. Cleaning and user maintenance shall not be made by children without supervision

Fan Assembly - Motion Sensor & Timer

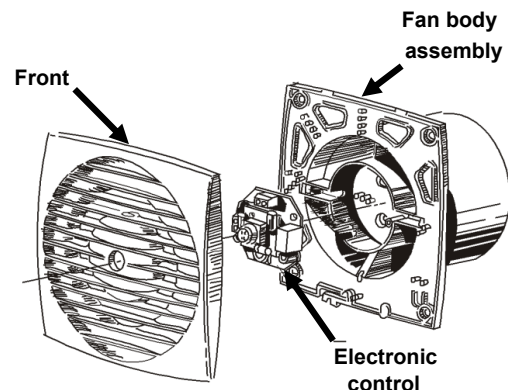

Page 11 of 16

Warranty

Airflow guarantees the Aria for 2 years from date of purchase against faulty material or workmanship, Applicable to unites installed and used in the UNITED KINGDOM.

Warranty covers the fan, not the re-installation of this if required. In the event of any defective parts being found, Airflow Developments Ltd reserves the right to repair, or at our discretion replace without charge provided the unit:

- Has been installed in accordance with the fitting and wiring instructions supplied with each unit.
- Has not been connected to an unsuitable electrical supply.
- Has not been subjected to misuse, neglect or damage.
- Has not been modified or repaired by any person not authorised by Airflow Developments Ltd.
- Has been installed by a person who is recognised as a competent person who is part of a competent scheme provider (e.g. NICEIC Ventilation Scheme).

Page 15 of 16

Through The Wall Installation

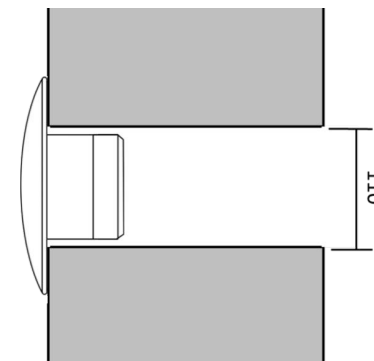

To maximise airflow rigid ducting should be used. Where flexible ducting is used the diameter must be maintained and it is good ventilation practice that the ducting is extended to 90% of its possible length in order to maintain the best possible airflow. Ensure that flexible duct connections are not over tightened to the fan outlet spigot.

The fan and ducting should be installed in accordance with the requirements of the Domestic Ventilation Compliance Guide, part of the Building Regulations.

Page 12 of 16



Airflow Developments Ltd shall not be liable for any loss, injury or other consequential damage, in the event of a failure of the equipment or arising from, or in connection with, the equipment excepting only that nothing in this condition shall be construed as to exclude or restrict liability for negligence. Full details at airflow.com/terms

This warranty does not in any way affect any statutory or other consumer rights.



Disposal

Do not dispose of with household waste. Please recycle where facilities exist.

Check with your local authority for recycling advice.



UK Head-Office
AIRFLOW DEVELOPMENTS Limited
Aidelle House, Lancaster Road
Cressex Business Park
High Wycombe
Buckinghamshire
HP12 3QP
United Kingdom

Tel: +44 (0) 1494 525252

Email: info@airflow.com
Web: airflow.com

Czech Republic
AIRFLOW LUFTECHNIK GmbH
o.s. Praha
Hostýnská 520
108 00 Praha 10
Malešice
Czech Republic

Tel: +42 (0) 2 7477 2230

Email: info@airflow.cz
Web: airflow.cz

Germany
Airflow Lufttechnik GmbH
Walbersacker 16
53359 Rheinbach
Germany

Tel: +49 (0) 222 69205 0

Email: info@airflow.de
Web: airflow.de

80000510 Issue 4 02/21

Page 16 of 16